

Single Phase 4.0Amp Glass passivated Bridge Rectifiers

MSBL



Features

- The plastic package carries Underwriters Laboratory Flammability Classification 94V-0
- Idea for printed circuit board
- Glass passivated junction chip
- Low reverse leakage
- High forward surge current capability
- High temperature soldering guaranteed 260°C/10 seconds at terminals

Mechanical Data

- Case : Molded plastic body
- Terminals : Solder plated, solderable per MIL-STD-750, Method 2026
- Polarity : Polarity symbol marking on body
- Mounting Position : Any

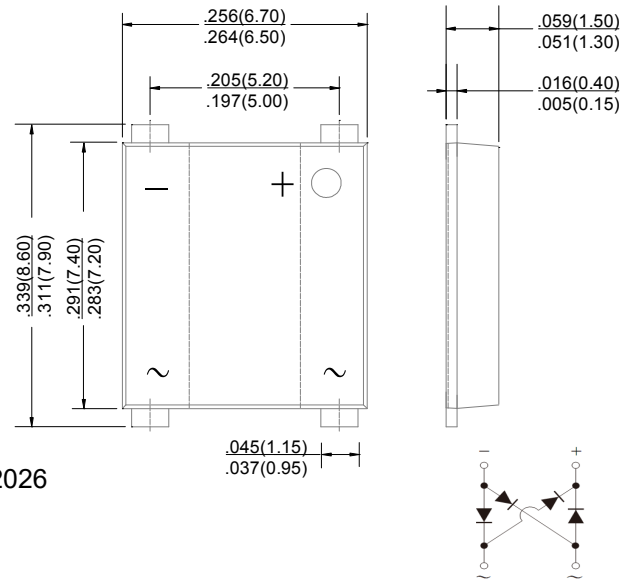

Dimensions in inches and (millimeters)

Maximum Ratings And Electrical Characteristics

Ratings at 25°C ambient temperature unless otherwise specified. Single phase half-wave 60Hz, resistive or inductive load, for capacitive load current derate by 20%.

Parameter	Symbols	MSB401	MSB402	MSB403	MSB404	MSB405	MSB406	MSB407	Units
Maximum repetitive peak reverse voltage	V_{RRM}	50	100	200	400	600	800	1000	V
Maximum RMS voltage	V_{RMS}	35	70	140	280	420	560	700	V
Maximum DC blocking voltage	V_{DC}	50	100	200	400	600	800	1000	V
Maximum average forward rectified current at $T_L=100^\circ\text{C}$	$I_{(AV)}$	4.0							A
Peak forward surge current, 8.3ms single half sine-wave superimposed on rated load	I_{FSM}	100.0							A
Rating for fusing ($t=8.3\text{ms}$, $T_a=25^\circ\text{C}$)	I_t^2	41.5							A^2s
Maximum instantaneous forward voltage at 4.0A	V_F	1.0							V
Maximum DC reverse current $T_A=25^\circ\text{C}$ at rated DC blocking voltage $T_A=125^\circ\text{C}$	I_R	2.0 200							μA
Typical junction capacitance (Note 1)	C_J	25.0							pF
Typical thermal resistance	R_{qJA}	55.0							$^\circ\text{C}/\text{W}$
Operating junction and storage temperature range	T_J, T_{STG}	-55 to +150							$^\circ\text{C}$

Note: 1. Measured at 1MHz and applied reverse voltage of 4.0V D.C.



Ratings And Characteristic Curves

FIG. 1- DERATING CURVE OUTPUT RECTIFIED CURRENT

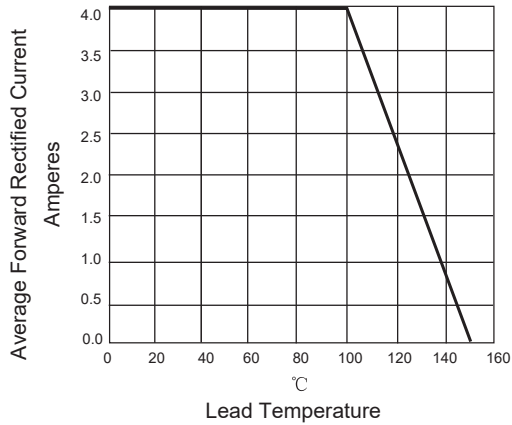

FIG. 2-MAXIMUM NON-REPETITIVE PEAK FORWARD SURGE CURRENT PER LEG

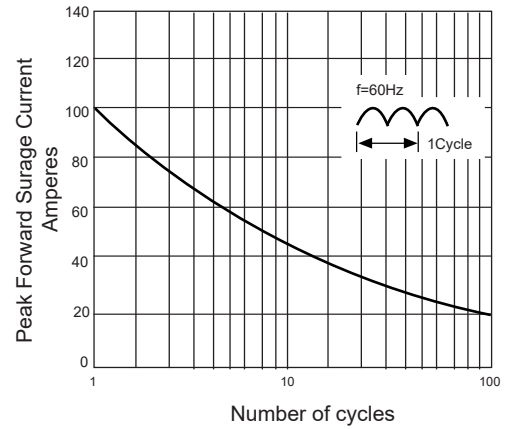

FIG. 3-TYPICAL FORWARD VOLTAGE CHARACTERISTICS

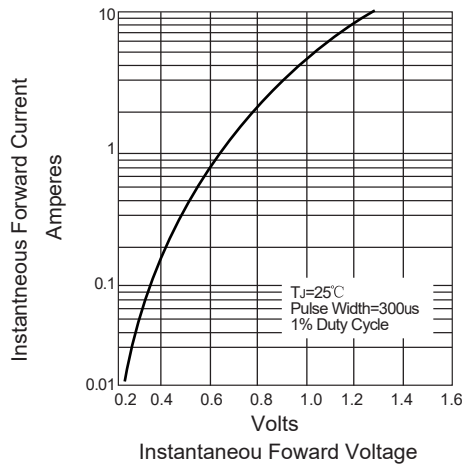
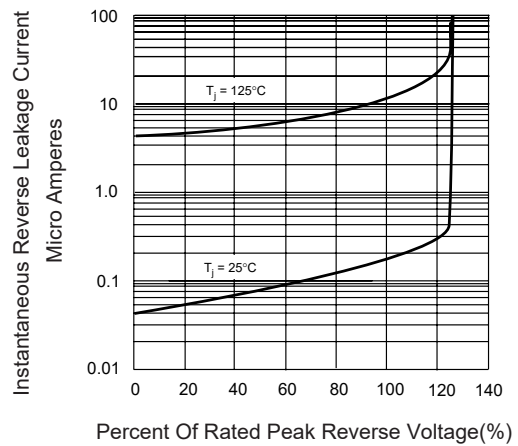
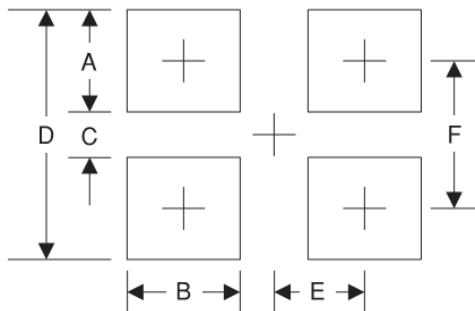

FIG. 4-TYPICAL REVERSE LEAKAGE CHARACTERISTICS



Suggested Pad Layout



Symbol	Unit (mm)	Unit (inch)
A	1.8	0.071
B	2.0	0.078
C	5.50	0.216
D	9.15	0.360
E	2.6	0.102
F	7.35	0.289



Marking

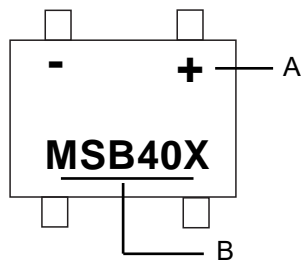

Symbol	Explanation
A	Polarity Symbol
B	Product Name, X: 1,2.....7

Suggested Soldering Temperature Profile

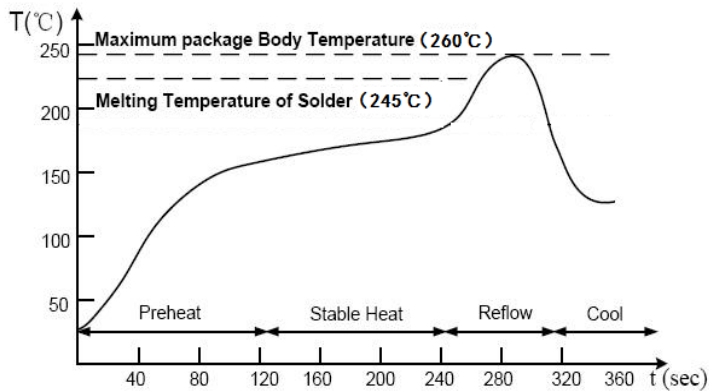

Note

- Recommended reflow methods: IR, vapor phase oven, hot air oven, wave solder.
- The device can be exposed to a maximum temperature of 260°C for 10 seconds.
- Devices can be cleaned using standard industry methods and solvents.
- If reflow temperatures exceed the recommended profile, devices may not meet the performance requirements.

Package Information

Carrier Dimension(mm)

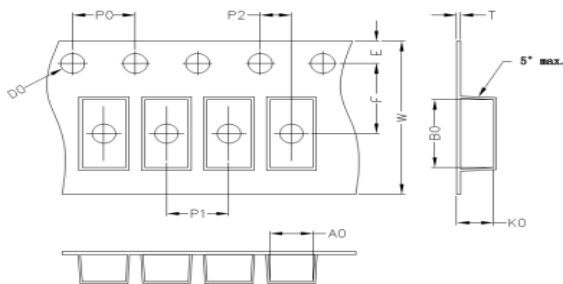

A0	B0	K0	D0	E	F
6.90	8.60	1.65	1.55	1.75	7.50
P0	P1	P2	T	W	Tolerance
4.0	12.0	2.0	0.30	16	0.1

Package Specifications

Package	Reel Size	Reel DIA. (mm)	Q'TY/Reel (Kpcs)	Box Size (mm)	QTY/Box (Kpcs)	Carton Size (mm)	Q'TY/Carton (Kpcs)
MSBL	13'	330	3	338	6	365*365*360	48